

T:\Engineering\Grid Profiles\2018\ACAD\Grid Profiles\CC\CC 10' STEEL LEG PROFILES.dwg  
 Apr 22, 2019 - 11:25am

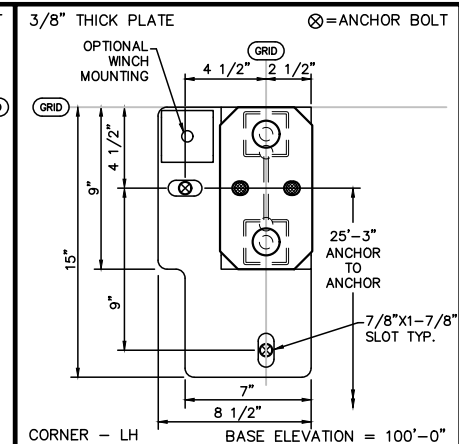
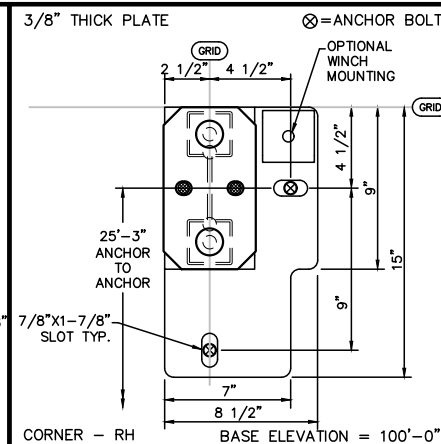
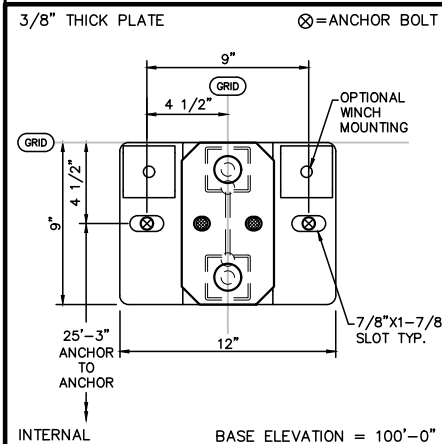
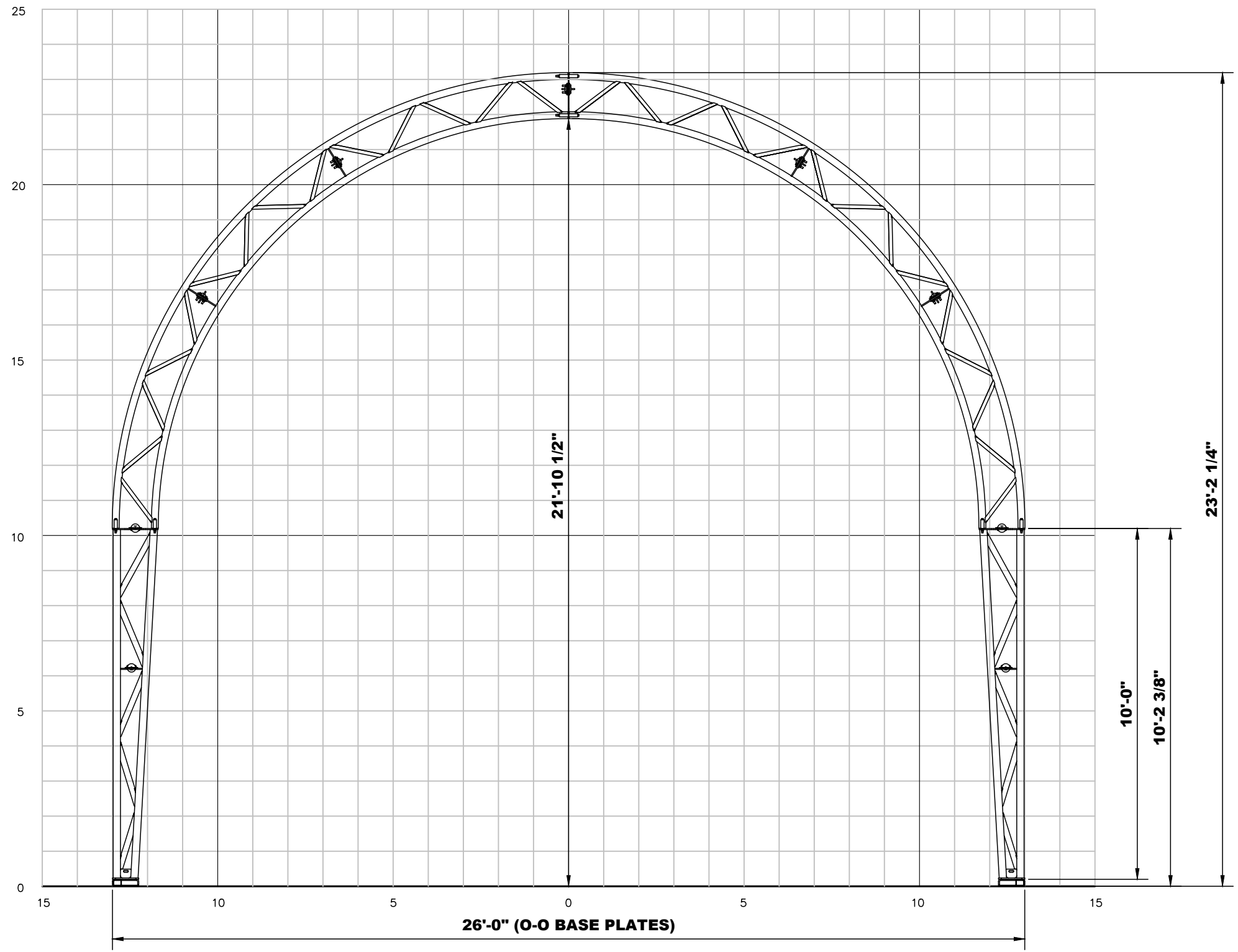

Calhoun Superstructure Ltd. 3702 Bruce Rd #10 Tara, Ontario, Canada M0H 2N0 800-265-3994 www.calhounsuperstructure.com		
NAME	DATE	
R D B	14/12/2018	
CHECKED	A G B 14/12/2018	
ENG. APPR.		
PROPRIETARY AND CONFIDENTIAL THE INFORMATION CONTAINED IN THIS DRAWING IS THE SOLE PROPERTY OF CALHOUN SUPERSTRUCTURE. ANY REPRODUCTION IN PART OR AS A WHOLE WITHOUT THE WRITTEN PERMISSION OF CALHOUN SUPERSTRUCTURE IS PROHIBITED		
No.	DESCRIPTION	DATE
REVISION / ISSUE		

**CALHOUN**

**26' CC PROFILE  
ON 10'-0" STEEL LEG**

SIZE: **D** DWG. NO. **CC-26**

SCALE: N T S SHEET 3 OF 7